

# V230

# Siat



## V230

## V230

### PRESSIONE

- Pressione di esercizio: \_\_\_\_\_ da 1.5 a 6 bar
- Resistenza statica alla pressione: \_\_\_\_\_ 22 bar

### PORTATA

- Portata di esercizio (Delta P = 1 bar): \_\_\_\_\_ 10 mc/h
- Portata di lavaggio in controcorrente: \_\_\_\_\_ max 4 mc/h
- Portata del lavaggio lento: \_\_\_\_\_ da 100 a 600 lt/h
- Portata lavaggio veloce in equicorrente: \_\_\_\_\_ max 5,5 mc/h

**QUANTITATIVO MAX DI RESINA RIGENERABILE:** \_\_\_\_\_ 300 lt

**TEMPERATURA DI ESERCIZIO:** \_\_\_\_\_ da 5 a 40° C

**MATERIALE CORPO VALVOLA:** \_\_\_\_\_ ABS + FV

### RIGENERAZIONE IN EQUI-CORRENTE

- Cicli regolabili: \_\_\_\_\_ a seconda del timer
- Durata Massima disponibile: \_\_\_\_\_ a seconda del timer

**POTENZA ELETTRICA** \_\_\_\_\_ vedi timer

### CICLI DELLA RIGENERAZIONE

- 1) Controlavaggio \_\_\_\_\_ contro-corrente
- 2) Aspirazione \_\_\_\_\_ equi-corrente
- 3) Lavaggio Lento \_\_\_\_\_ equi-corrente
- 4) Lavaggio Rapido + Salamoia \_\_\_\_\_ equi-corrente
- 5) Servizio \_\_\_\_\_ equi-corrente

### DIMENSIONI

- Attacco Bombola: \_\_\_\_\_ 4" 8UN
- Tubo distributore: \_\_\_\_\_ Ø 50 mm
- Conduittura allo scarico: \_\_\_\_\_ Ø 20 mm o 1" fil. maschio
- Conduittura alla salamoia: \_\_\_\_\_ 3/8"

### RACCORDI INGRESSO/USITA DISPONIBILI

- raccordo pvc 2"x1" ¼ femmina/femmina
- raccordo pvc 2"x ISO d. 40 femmina/femmina incollaggio
- raccordo ottone 2"x1" ½ femmina/maschio

### -ACCESSORI/OPZIONI

- Valvola filtro
- Valvola per impianti di Demineralizzazione
- Valvola Salamoia
- By-Pass
- Produttore di cloro originale (solo abbinato con Timer ACL)
- No By-Pass Acqua grezza (a seconda del timer e con valvola idropneumatica)

### CERTIFICATI

- Conformità al DM 174 del 06/04/2004
- 2002/95/EC (RoHS)

### PRESSIONE

- Operating Pressure: \_\_\_\_\_ from 1.5 to 6 bar
- Static resistance to pressure: \_\_\_\_\_ 22 bar

### FLOW RATE

- Service Flow rate (1 bar drop): \_\_\_\_\_ 10 mc/h
- Backwash: \_\_\_\_\_ max 4 mc/h
- Slow rinse: \_\_\_\_\_ from 100 to 600 lt/h
- Fast rinse: \_\_\_\_\_ max 5,5 mc/h

**MAXIMUM QUANTITY OF REGENERATIVE RESIN:** \_\_\_\_\_ 300 lt

**OPERATING TEMPERATURE:** \_\_\_\_\_ from 5 to 40° C

**VALVE MATERIAL:** \_\_\_\_\_ ABS + FV

### DOWNFLOW REGENERATION

- Adjustable cycles: \_\_\_\_\_ depend on the timer
- Time available: \_\_\_\_\_ depend on the timer

**ELECTRICAL RATE** \_\_\_\_\_ see timers

### REGENERATION CYCLE

- 1) Backwash \_\_\_\_\_ Upflow
- 2) Brine \_\_\_\_\_ Downflow
- 3) Slow Rinse \_\_\_\_\_ Downflow
- 4) Rapid Rinse + Brine Refill \_\_\_\_\_ Downflow
- 5) Servizio \_\_\_\_\_ Downflow

### DIMENSIONS

- Mounting base: \_\_\_\_\_ 4" 8UN
- Distributor pilot: \_\_\_\_\_ Ø 50 mm
- Drain line: \_\_\_\_\_ Ø 20 mm or 1" threaded male
- Brine line: \_\_\_\_\_ 3/8"

### PIPING FITTING IN/OUT AVAILABLE (BAYONET)

- pvc fitting 2"x1" ¼ female/female
- pvc fitting 2"x ISO d. 40 female/female glue
- brass fitting 2"x1" ½ female/male

### ACCESSORIES/OPTIONS

- Filter Valve
- Demineralization Valve
- Brine Valve
- By-Pass
- chlorine generator (sonly ACL Timer)
- No By-Pass raw water (depend on the timer and with idropneumatic valve)

### CERTIFICATES

- DM 174 DD April 06, 2004 compliance
- 2002/95/EC (RoHS)

## PORTATA DI SERVIZIO/SERVICE FLOW RATE

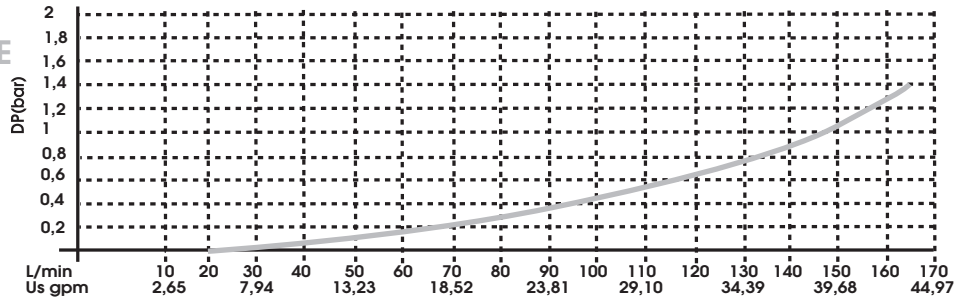

## SCHEMI DI FLUSSO/FLOW DIAGRAMS

### 1 SERVIZIO/SERVICE

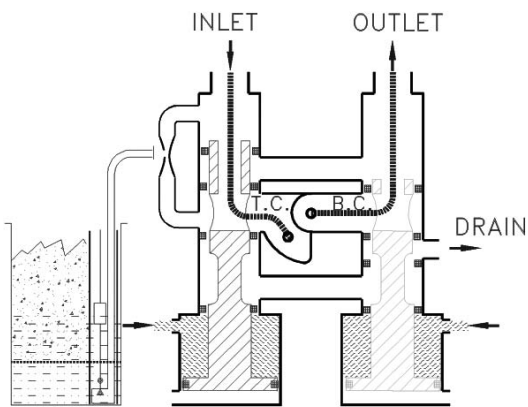

### 2 CONTROLAVAGGIO/BACHWASH

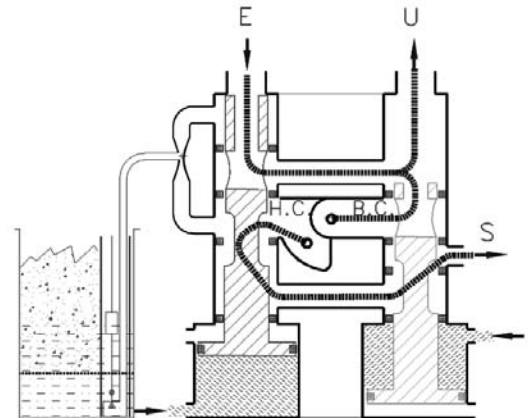

### 3 ASPIRAZIONE/SUCTION

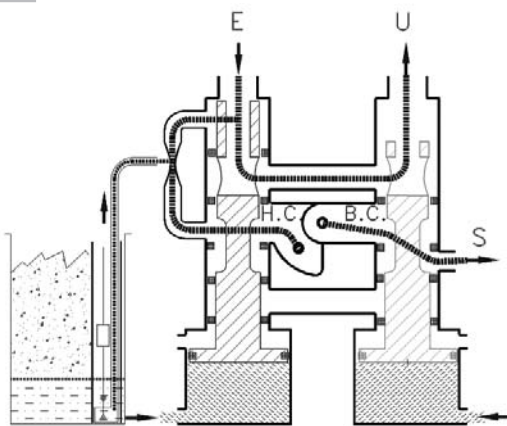

### 4 LAVAGGIO LENTO/SLOW RINSE

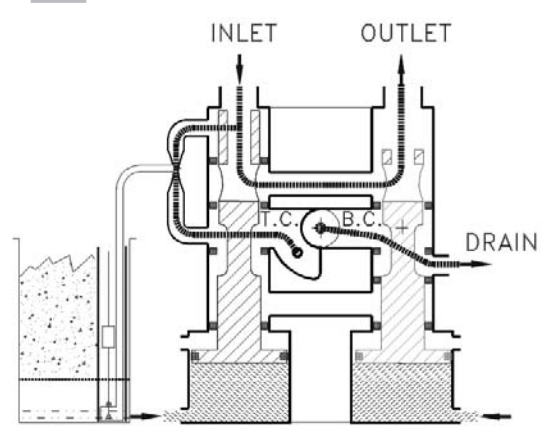

### 5 LAVAGGIO RAPIDO/FAST RINSE

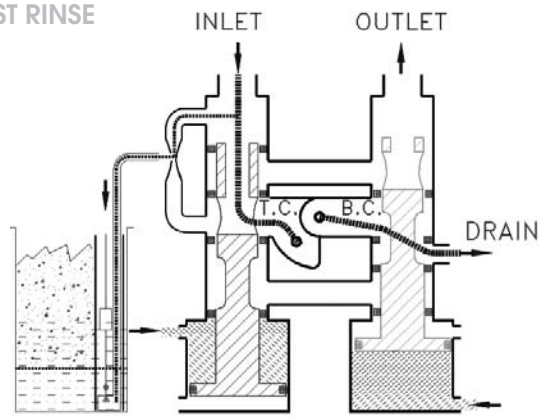

### CARATTERISTICHE GENERALI

Le valvole V230 costituiscono l'elemento essenziale per la realizzazione di impianti di vario tipo ed utilizzo:

- a) addolcimento (decalcificazione) singolo o duplex o più colonne, ad uso domestico, da laboratorio e industriale.
- b) demineralizzazione e decarbonatazione, singolo o duplex, per usi di laboratorio e industriale, e per tutti gli impieghi ove si renda necessaria di un tipo d'acqua con caratteristiche di qualità garantita.
- c) filtrazione singola o duplex per tutte le applicazioni precedenti.

Le valvole sono costruite con materiali che garantiscono la massima resistenza e qualità. Le valvole dispongono di una vasta gamma di timer, per il controllo di tutte le fasi operative di servizio e di rigenerazione, partendo dal più semplice timer elettromeccanico con orologio settimanale, ai sofisticati timer elettronici, nei vari modelli, che consentono controlli volumetrici, volumetrici/tempo, controllo di salinità in microsiemens/cm etc. Nei sistemi elettronici tutti i tempi di intervento, delle fasi operative, sono programmabili in relazione al tipo e dimensione dell'impianto, per le caratteristiche specifiche dei timer vedere la sezione timer.

### SCHEMI VARIANTI ADDOLCIMENTO

- A) Schema addolcimento duplex con due valvole di misura salamoia, lavaggio lento, valvola di uscita 3v. timer piloti:



- B) Schema addolcimento duplex con valvola di misura salamoia, lavaggio lento e dispositivo automatico/dinamico, per la selezione della linea in aspirazione. timer piloti. valvola 3v:

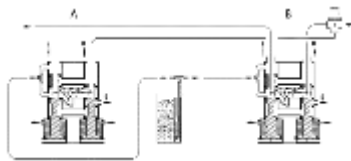

- C) Schema addolcimento duplex senza lavaggio lento (contenitore sale/salamoia alimentato separatamente) senza valvola di misura salamoia. timer 5 piloti. valvola 3v:

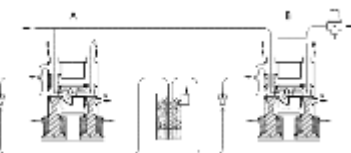

- E) Schema addolcimento duplex con lavaggio lento (contenitore sale/salamoia alimentato separatamente), senza valvola di misura salamoia. Timer 7 piloti. Valvola 3V

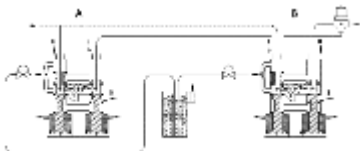

- F) Schema addolcimento Duplex senza lavaggio lento (contenitore sale/salamoia alimentato separatamente), due valvole di uscita "a" e "b". Timer 5 piloti. Senza valvola di misura salamoia:

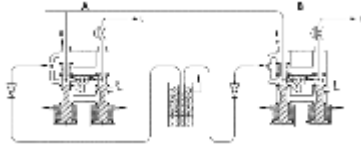

- G) Schema addolcimento duplex con lavaggio lento (contenitore sale/salamoia alimentato separatamente), due valvole di uscita "a" e "b". Timer 7 piloti. Senza valvola di misura salamoia:

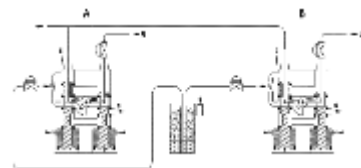

- H) Schema demineralizzazione senza valvole per lavaggio lento, timer 5 piloti:

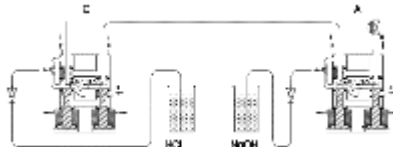

- I) Schema demineralizzazione con valvole per lavaggio lento, timer 7 piloti:

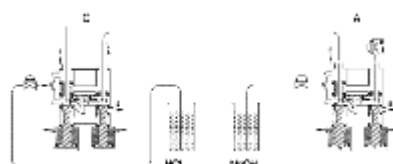

Collegamenti addolcimento duplex riferimento schemi "A", "B", "C".

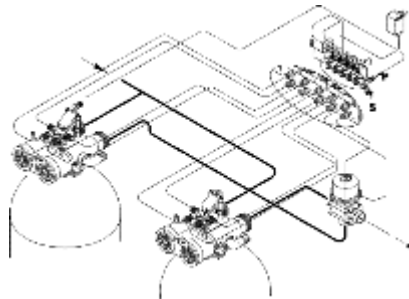

Collegamenti addolcimento duplex riferimento schema "F".

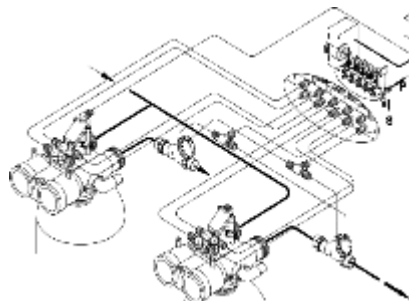

Collegamenti addolcimento duplex riferimento schema "E".

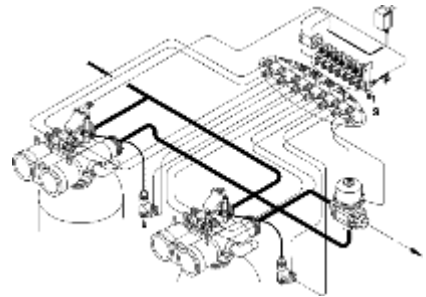

Collegamenti addolcimento duplex riferimento schema "G".

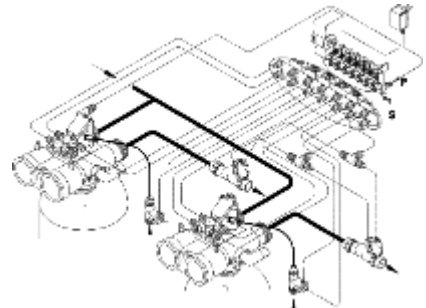

Collegamenti demineralizzatore riferimento schema "H".

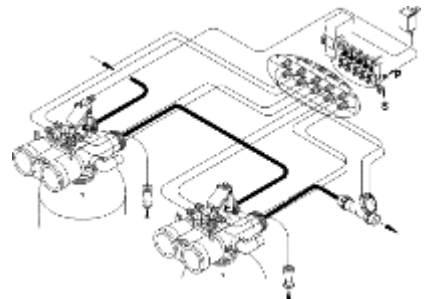

Collegamenti demineralizzatore riferimento schema "I".

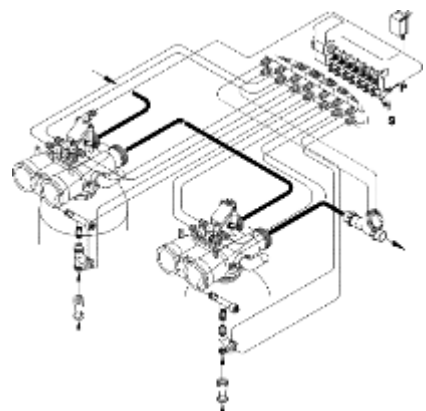

### SPORGENZA TUBO DISTRIBUTORE

Sporgenza max 3 mm

Smussare l'imbocco del tubo max 1 mm

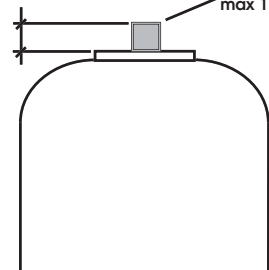

## SERVICE MANUAL

### GENERAL FEATURES

V230 valves are the essential elements in building the following systems:  
 a) simplex, duplex or multi-tank softening (decalcification) systems for domestic, laboratory and industrial use;  
 b) simplex or duplex demineralisation and dealkalisation systems for laboratory and industrial use and all other uses requiring water with characteristics of guaranteed quality;

c) simplex or duplex filtering systems for all of the previous applications. The valves are made with materials that guarantee utmost resistance and quality.

They are available with a vast range of controllers for every operation phase of service and regeneration, starting from the simplest electronic basic controller with weekly clock to the sophisticated electronic controllers in various models which enable volume, volume-time control and salinity control in MicroSiemens/cm, etc.

In the electronic systems, all the intervention times of operation phases can be programmed in relation to system type and dimension.

For specific controller features, see the relative controller section.

### SOFTENING VERSIONS SCHEMES

- A) Duplex softening scheme with two brine measure valves, slow rinse, 3V output valve. 5 pilot valve controller:



- B) Duplex softening scheme with brine measure valve, slow rinse and automatic/dynamic device to determine brine-draw line. 5 pilot valve controller. 3V valve:

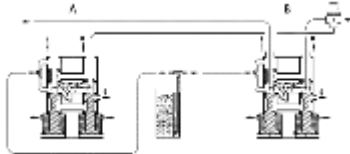

- C) Duplex softening scheme without slow rinse, (salt-brine container fed separately), without brine-measure valve. 5 pilot valve controller. 3V valve:

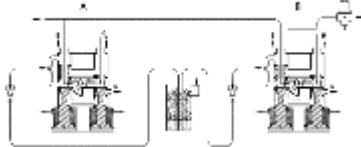

- E) Duplex softening scheme with slow rinse (Salt/brine container fed separately) without brine-measure valve. 7 pilot valve controller. 3V valve:

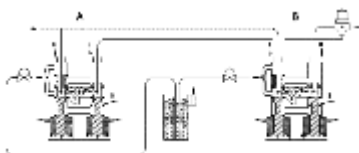

- F) Duplex softening scheme without slow rinse (Salt/brine container fed separately) Two output valves "A" and "B". 5 pilot valve controller. Without brine measure valve:

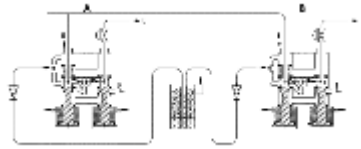

- G) Duplex softening scheme with slow rinse (Salt/brine container fed separately) Two output valves "A" and "B". 7 pilot valve controller. Without brine measure valve:

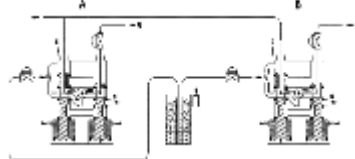

- H) Demineralisation scheme without valves for slow rinse, 5 pilot valve controller. Attention! Dissuaded application:

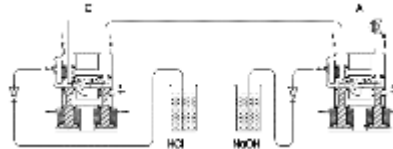

- I) Demineralisation scheme with valves for slow rinse, 7 pilot valve controller. Attention! Application Recommended:

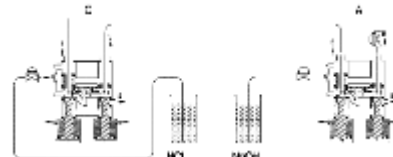

Duplex softening connections referring to schemes "A", "B", "C".

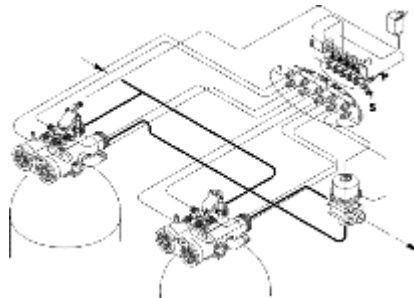

Duplex softening connections referring to schemes "F".

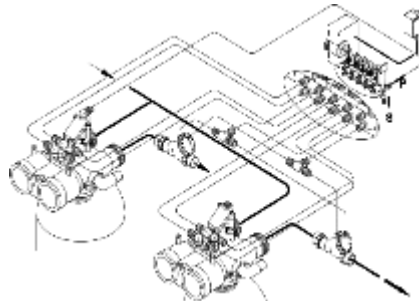

Duplex softening connections referring to schemes "E".

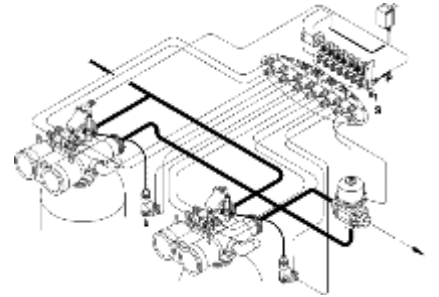

Duplex softening connections referring to schemes "G".

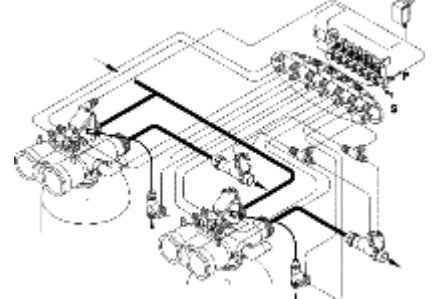

Deionisation connections referring to schemes "H".

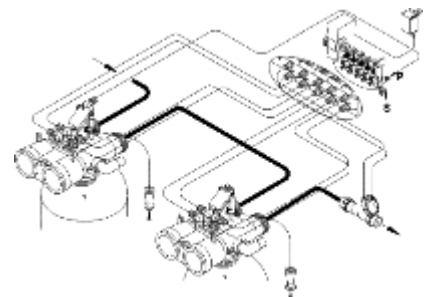

Deionization connections referring to schemes "I".

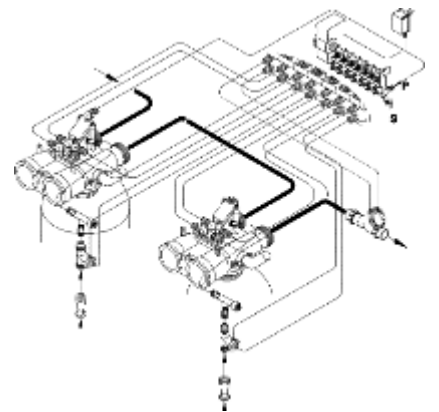

### PROJECTION TUBE PILOT

Maximum projection 3 mm

Cut off tub tip max 1 mm

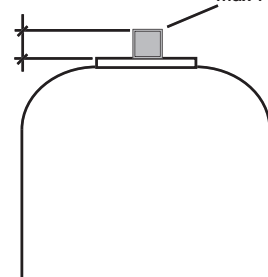



DIMENSIONI/DIMENSIONS

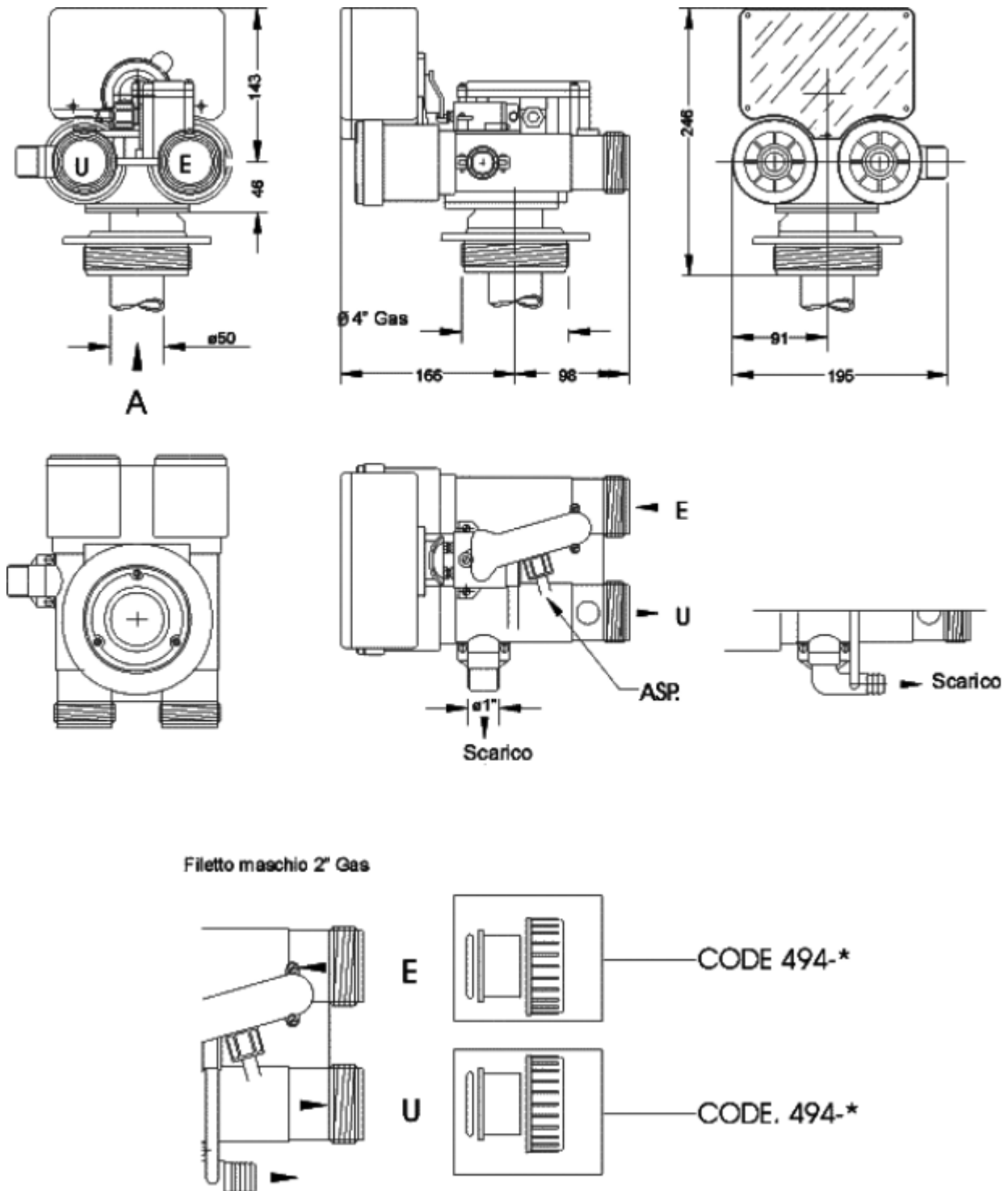



**VARIANTE VOLUMETRICA STANDARD**

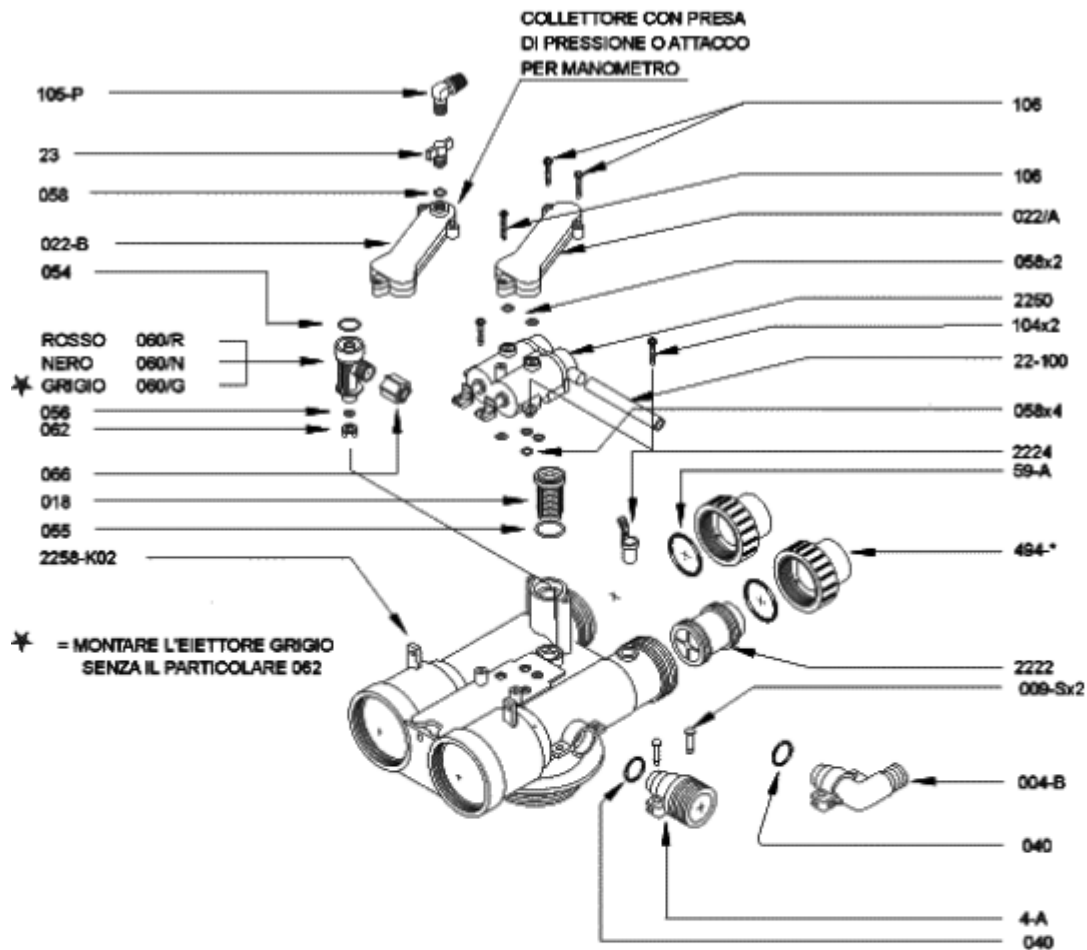

**VARIANTE BY-PASS DIRETTO**

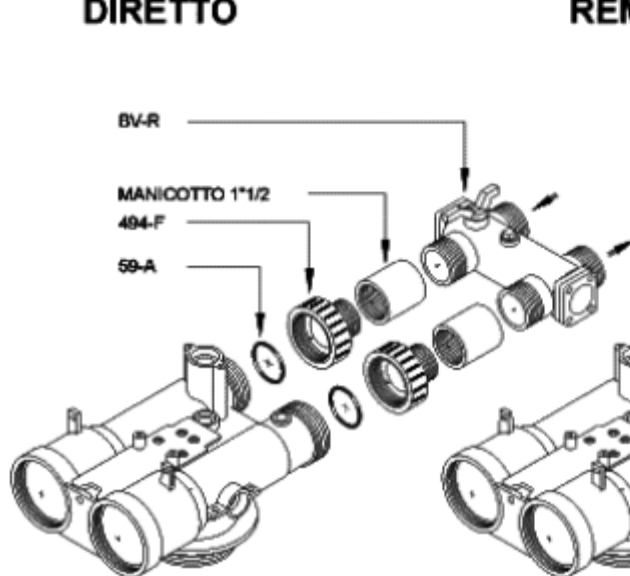

**VARIANTE BY-PASS REMOTO**

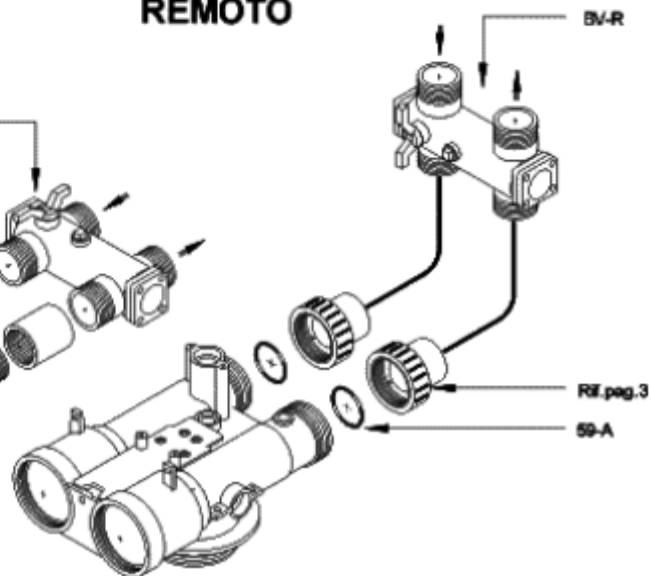

**VARIANTE FILTRAZIONE**

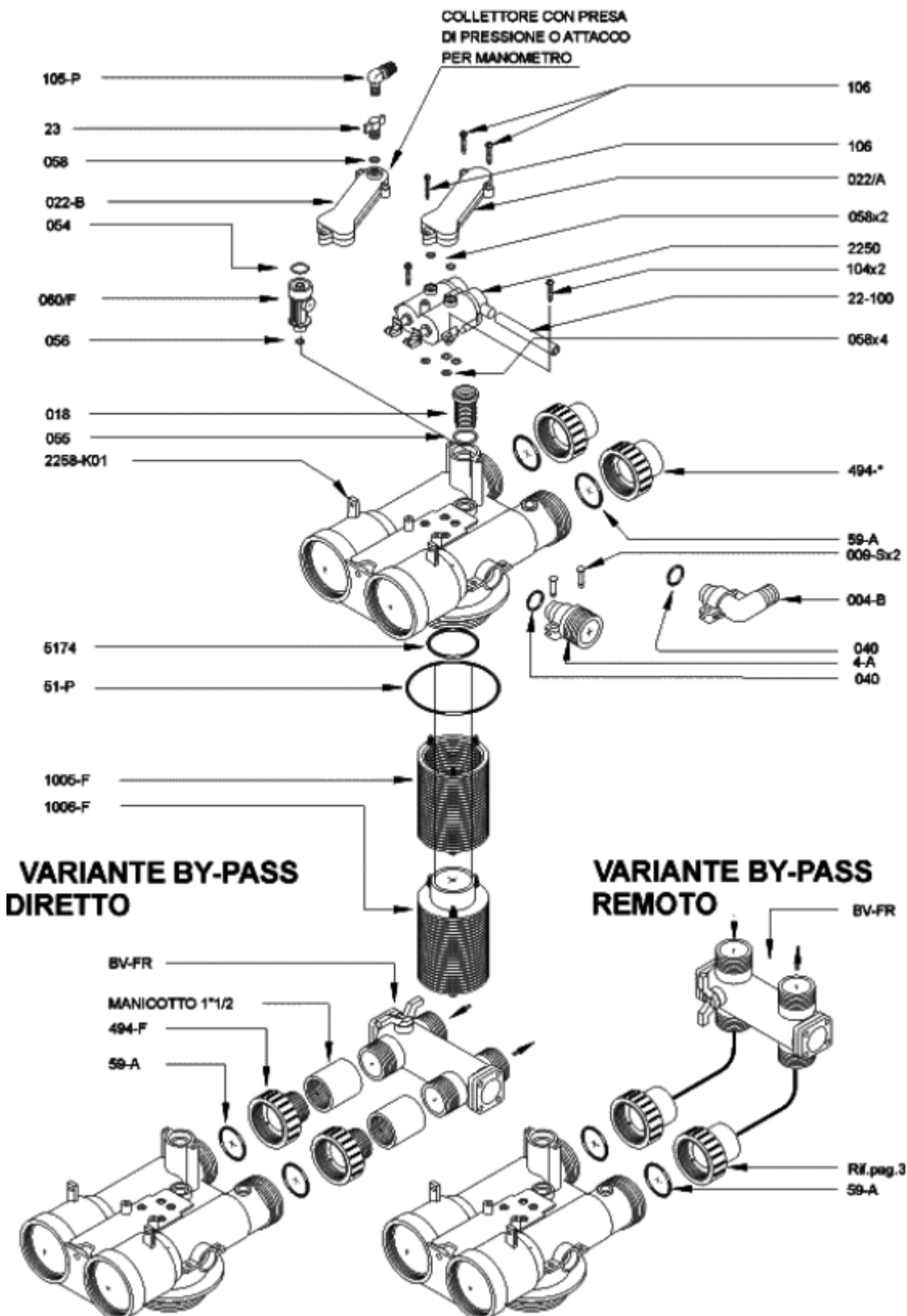



## VARIANTE DUPLEX E DEMINERALIZZAZIONE

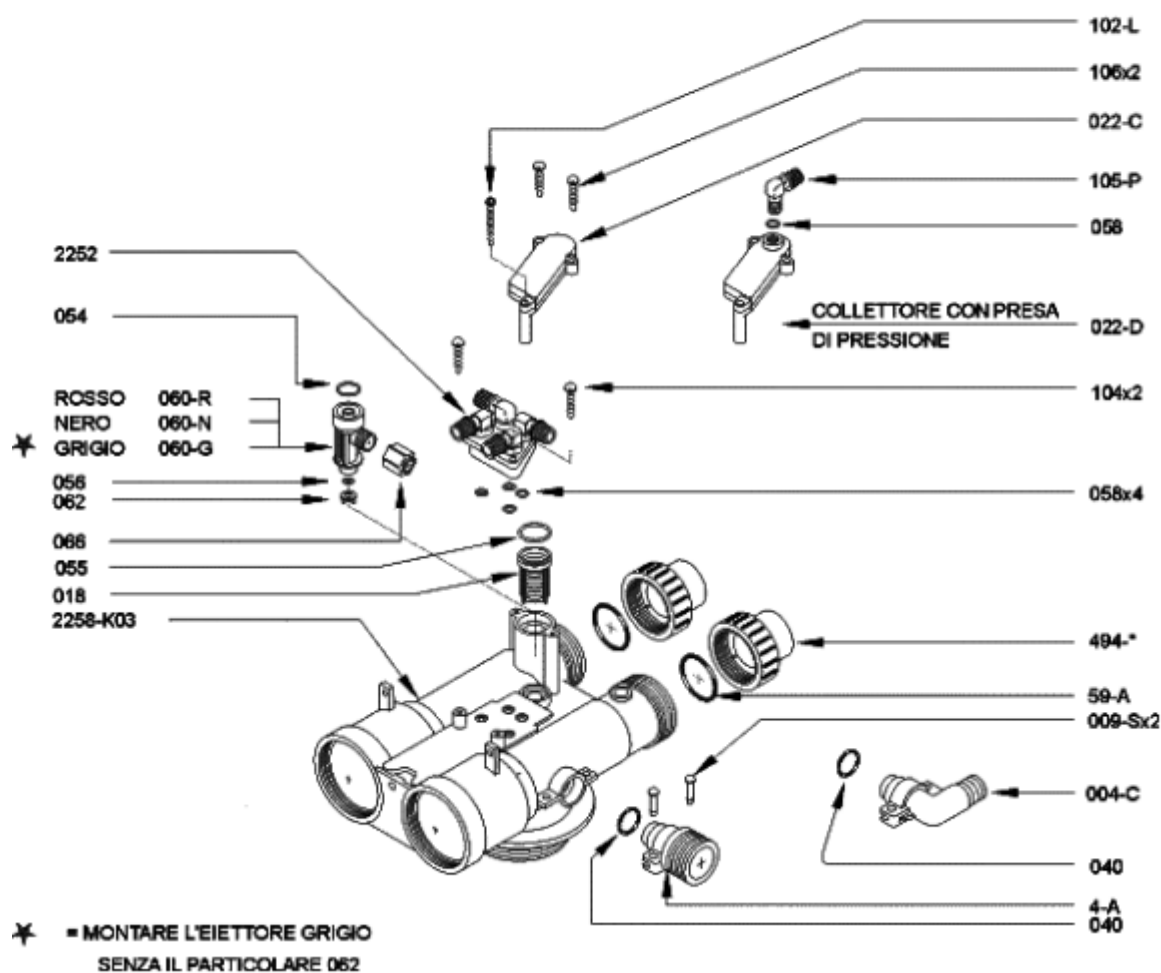

## EIETTORI PER VALVOLA SIATA V230/INJECTORS FOR SIATA VALVE V230

| EIETTORE<br>(INJECTOR) | VOLUME DI RESINA<br>(VOLUME OF RESIN) | PORTATA SCARICO<br>(DRAIN FLOW) | Ø SCARICO<br>(Ø FLOW CONTROL) |
|------------------------|---------------------------------------|---------------------------------|-------------------------------|
| Marrone/Brown          | 10 - 20 lt                            | 320 lt/h                        | 3 mm (Ø70/1)                  |
| Blu/Blue               | 21 - 30 lt                            | 480 lt/h                        | 3,5 mm (Ø70/2)                |
| Blu/Blue               | 31 - 36 lt                            | 700 lt/h                        | 4 mm (Ø70/3)                  |
| Rosso/Red              | 37 - 42 lt                            | 700 lt/h                        | 4 mm (Ø70/3)                  |
| Rosso/Red              | 43 - 55 lt                            | 950 lt/h                        | 5 mm (Ø70/4)                  |
| Rosso/Red              | 56 - 68 lt                            | 1450 lt/h                       | 6 mm (Ø70/5)                  |
| Nero/Black             | 69 - 80 lt                            | 1450 lt/h                       | 6 mm (Ø70/5)                  |
| Nero/Black             | 81 - 160 lt                           | - lt/h                          | -                             |
| Grigio/Grey            | 161 - 300 lt                          | - lt/h                          | -                             |

## RICAMBI V230/SPARE PARTS V230

**PS1040**  
Kit Pilotino  
(Twin pilots)



**PS1041**  
Kit Connessioni Esterne  
(External Connections)



**PS1021**  
4 connessioni  
(4 connection)



**PS1022**  
5 connessioni  
(5 connection)



**PS1019**  
2 piloti  
(Twin pilots)



Kit Eiettore  
(Kit injector)



**PS1029** Blu/Blue  
**PS1030** Filtro/Filter  
**PS1031** Grigio/Grey  
**PS1032** Marrone/Brown  
**PS1033** Nero/Black  
**PS1034** Rosso/Red

**PS1028**  
Kit Pistoni  
(Piston kit)

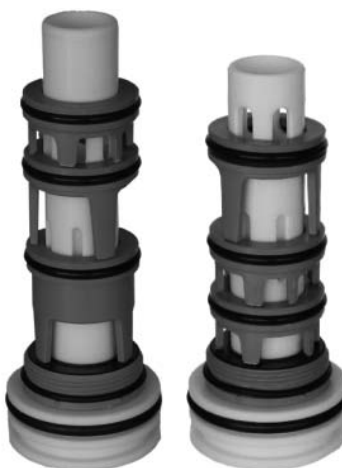

**PS1026**  
Turbina  
(Turbine)



Filtro superiore  
(Top filter)  
**PS1002** 0.3 mm  
**PS1003-1** 0.8 mm

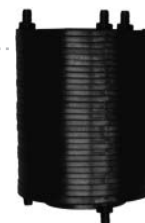

Filtro di fondo  
(Bottom filter)  
**PS1003** 0.3 mm  
**PS1003-2** 0.8 mm



**PS1037**  
Collettore scarico  
per 2 piloti  
(twin pilot drain  
connection)



**PS1039**  
Collettore scarico  
per senza i 2 piloti  
(without twin pilot  
drain connection)



**PS1038**  
Connettore scarico  
filettato  
(Threaded connector)



**PS1024**  
Raccordo baionetta x  
PS1041  
(Quick baionet  
connector for PS1041)



**PS1018-1**  
Tappo pistone con foro  
filettato  
(Body cup with threaded  
hole)



**PS1315**  
Valvola non ritorno  
per HCl  
(Anti Backflow for  
HCl)



**PS1314**  
Valvola non ritorno  
per NaOH  
(Anti Backflow for  
NaOH)



## ACCESSORI V132/ACCESSORIES V132

**PS0625**  
By-Pass diretto con miscelatore  
(Direct By-Pass with mixer)



**PS0630**  
By-Pass diretto con mixer e prelievi  
(Direct By-Pass with mixer and  
sample taps)



**PS0645**  
By-Pass remoto  
(Remote By-Pass)



**PS0620**  
Valvola salamoia 3/8"  
(3/8" Brine valve)



COLLEGAMENTI TIMER VALVOLA/TIMER VALVE CONNECTIONS

**1** Addolcitore o filtro singolo con timer 2 piloti. Valvole utilizzabili: V230E, V230E-T. By-pass Acqua dura durante la rigenerazione nella 1<sup>a</sup>, 2<sup>a</sup> e 3<sup>a</sup> fase. Controllo salamoia tramite valvola PS0620.

(Single softening or filtration system with timer 2 pilots. Usable valves: V230E, V230E-T. By-pass hard water during the regeneration in 1st, 2nd and 3rd cycle. Brine control by PS0620).

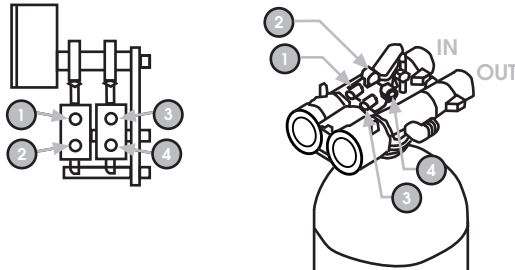

**2** Addolcitore o filtro singolo con timer 3 piloti. Valvole utilizzabili: V230E, V230E-T. NO By-pass Acqua dura durante la rigenerazione tramite valvola idropneumatica. Controllo salamoia tramite valvola PS0620.

(Single softening or filtration system with timer 3 pilots. Usable valves: V230E, V230E-T. NO By-pass hard water during the regeneration with idropneumatic valve). Brine control by PS0620.

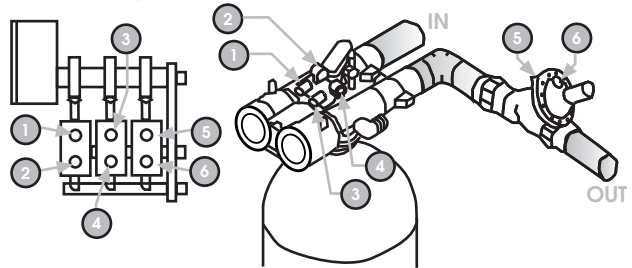

**3** Addolcitore singolo con timer 3 piloti con controllo aspirazione. Valvole utilizzabili: V230E, V230E-T. By-pass Acqua dura durante la rigenerazione nella 1<sup>a</sup>, 2<sup>a</sup> e 3<sup>a</sup> fase.

(Single softening system with timer 3 pilots with apiration control. Usable valves: V230E, V230E-T. By-pass hard water during the regeneration in 1st, 2nd and 3rd cycle).

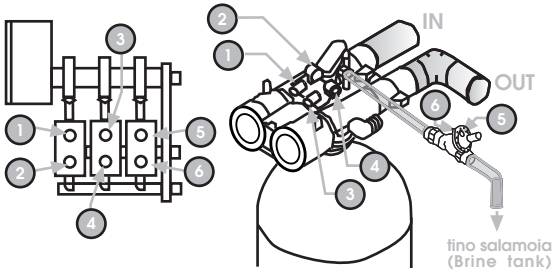

**4** Addolcitore singolo con timer 4 piloti con controllo aspirazione e chiusura utilizzo. Valvole utilizzabili: V230E, V230E-T. NO By-pass Acqua dura durante la rigenerazione tramite valvola idropneumatica.

(Single softening system with timer 4 pilots with apiration control and use cloruse. Usable valves: V230E, V230E-T. NO By-pass hard water during the regeneration with idropneumatic valve).

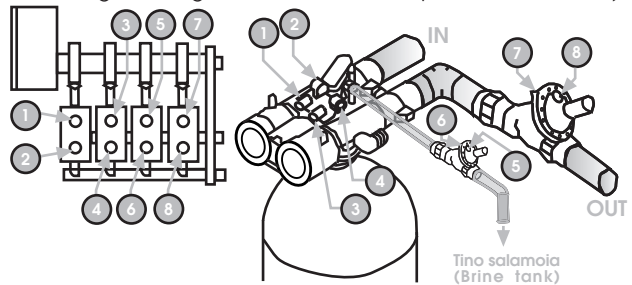

**5** Addolcitore duplex alternato con timer 5 piloti. Valvole utilizzabili: V230E, V230E-T. NO By-pass Acqua dura durante la rigenerazione tramite valvola idropneumatica. Controllo salamoia tramite valvola PS0620.

(Alternate Duplex softening system with timer 5 pilots. Usable valves: V230E, V230E-T. NO By-pass hard water during the regeneration with idropneumatic valve. Brine control by PS0620).

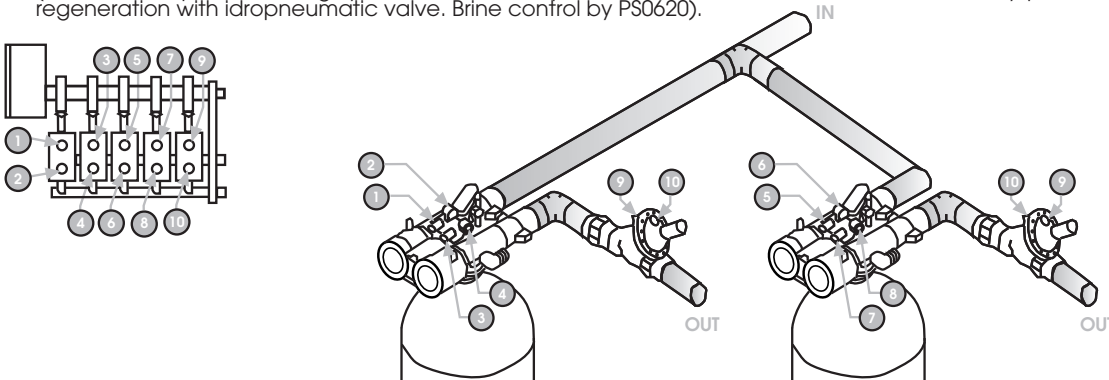

**6** Addolcitore duplex alternato con timer 7 piloti. Valvole utilizzabili: V230E, V230E-T. NO By-pass Acqua dura durante la rigenerazione tramite valvola idropneumatica. Controllo aspirazione salamoia tramite valvola idropneumatica.

(Alternate Duplex softening system with timer 7 pilots. Usable valves: V230E, V230E-T. NO By-pass hard water during the regeneration with idropneumatic valve. Brine line control by idropneumatic valve).

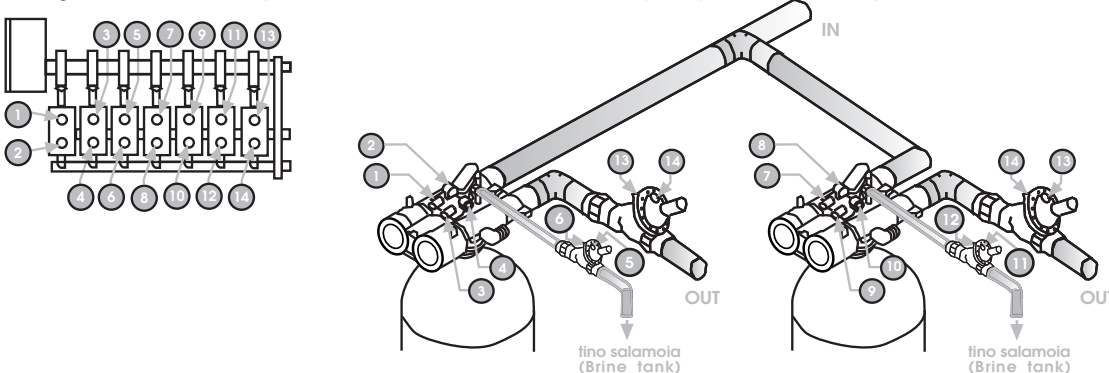

**7** Demineralizzatore con timer 5 piloti. Valvola utilizzabile: V230D/05. NO By-pass Acqua grezza durante la rigenerazione tramite valvola idropneumatica. Aspirazione rigeneranti tramite PS1314 e PS1315.  
 (Demineralization system with timer 5 pilots. Usable valve: V230D/05. NO By-pass raw water during the regeneration with idropneumatic valve. Rigenerant suction by PS1314 e PS1315).

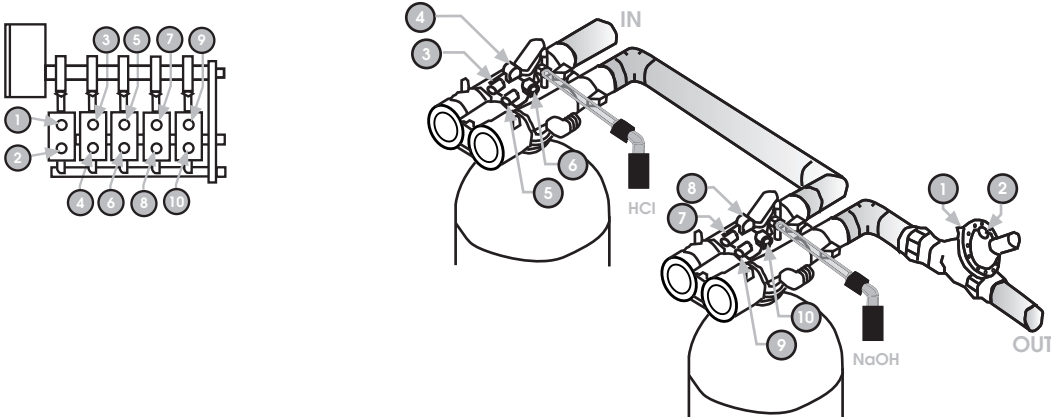

**8** Demineralizzatore con timer 7 piloti. Valvola utilizzabile: V230D/05. NO By-pass Acqua grezza durante la rigenerazione tramite valvola idropneumatica. Aspirazione rigeneranti tramite valvole idropneumatiche.  
 (Demineralization system with timer 7 pilots. Usable valve: V230D/05. NO By-pass raw water during the regeneration with idropneumatic valve. Rigenerant suction by idropneumaic valves).

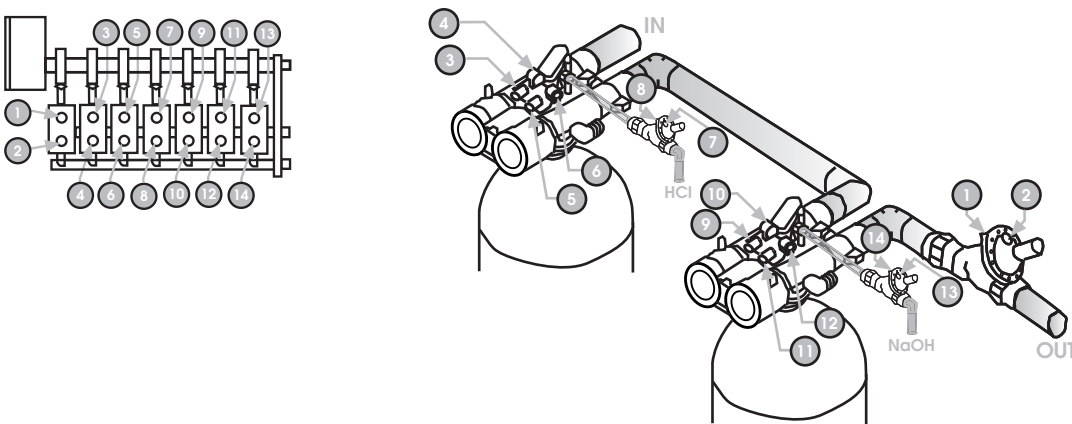

**9** Demineralizzatore 3 colonne con timer 7 piloti. Valvola utilizzabile: V230D/05. NO By-pass Acqua grezza durante la rigenerazione tramite valvola idropneumatica. Aspirazione rigeneranti tramite valvole di non ritorno PS1314 e PS1315.  
 (Demineralization system 3 step with timer 7 pilots. Usable valve: V230D/05. NO By-pass raw water during the regeneration with idropneumatic valve. Rigenerant suction by anti-backflow valve PS1314 and PS1315).

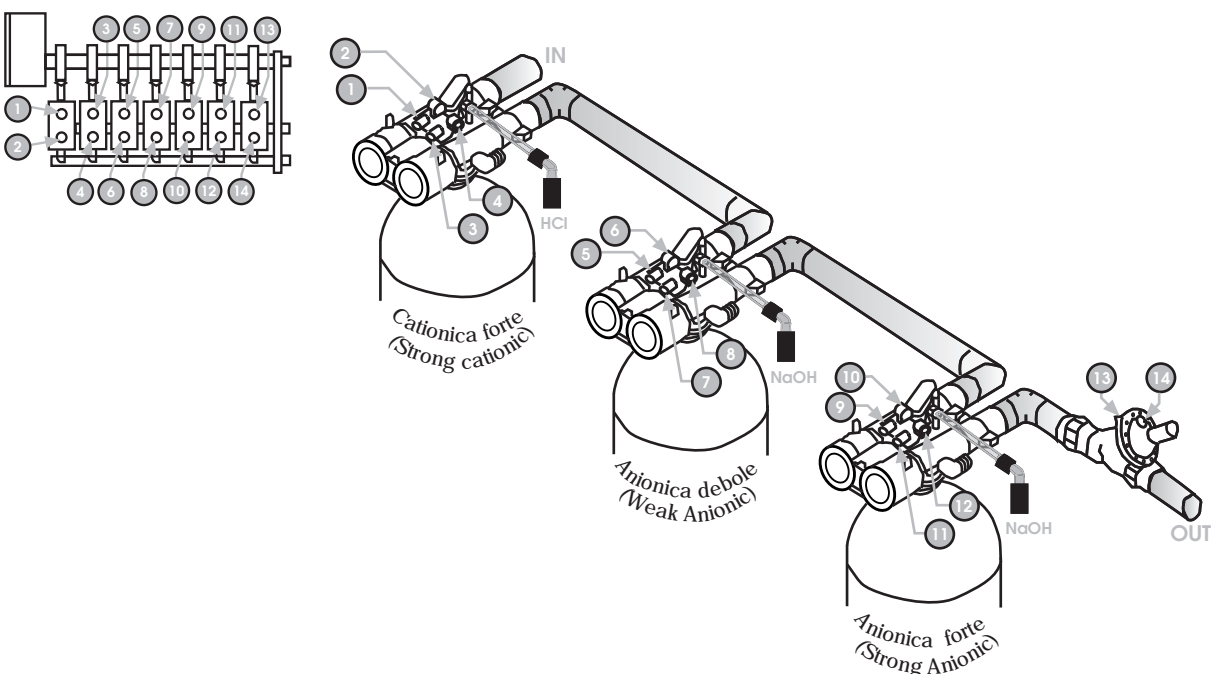

- 10 Filtro duplex rigenerazione in cascata con timer 5 piloti. Valvola utilizzabile: V230E (con eiettore per filtro). NO By-pass Acqua grezza durante la rigenerazione tramite valvola idropneumatica.**  
 (Series Duplex Filter system with timer 5 pilots. Usable valve: V230E (with injector for filter). NO By-pass raw water during the regeneration with idropneumatic valve).

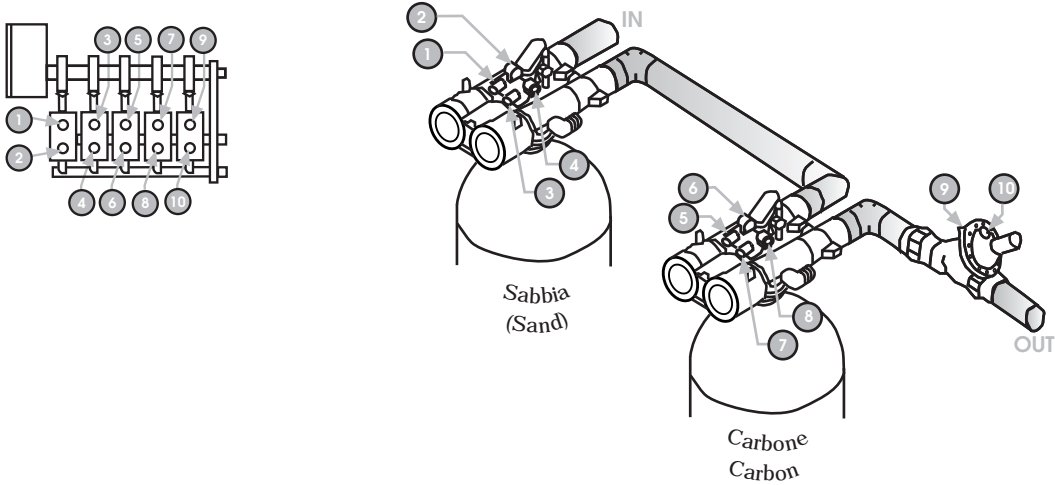

- 11 Addolcitore Duplex alternato con timer 5 piloti. Valvole utilizzabili: V230E, V230E-T. NO By-pass Acqua grezza durante la rigenerazione tramite valvola 3 vie. Controllo salamoia tramite valvola PS0620.**  
 (Alternate Duplex softening system with timer 5 pilots. Usable valves: V230E, V230E-T. NO By-pass hard water during the regeneration with 3 way valve. Brine control by PS0620).

